

ROHS

NOTES:

SPECIFICATION:

1. CURRENT RATING: 3.0A MAX
2. VOLTAGE: 100 VAC
3. TEMPERATURE RANGE: -30 °C ~ 85 °C
4. CONTACT RESISTANCE: 40 MILLIONHM MAX
5. INSULATION RESISTANCE: 100 MEGOHMS MIN.
6. INSERTION FORCE : 5N~20N
7. UNMATING FORCE: 8N~20N
8. DURABILITY: 10,000 CYCLES
9. WATER PROOFNESS: THIS PRODUCT IS BASED ON IPX7.

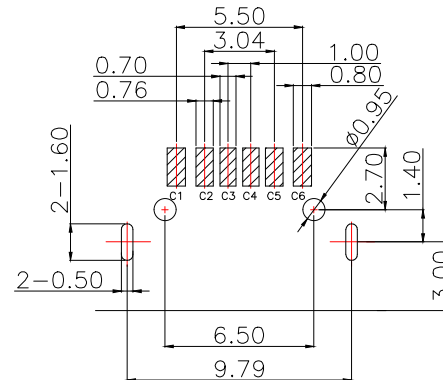

RECOMMENDED P.C.B. LAYOUT
TOLERANCE UNSPECIFIED ±0.05mm

PIN NO	A1&B12	A4&B9	A5	A5	A9&B4	A12&B1
SIGNAL NAME	GND	VBUS	CC1	CC2	VBUS	GND
PCB PAD NO.	C1	C2	C3	C4	C5	C6

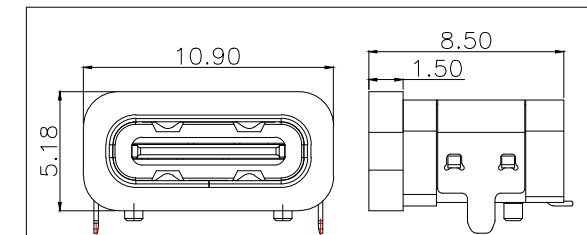
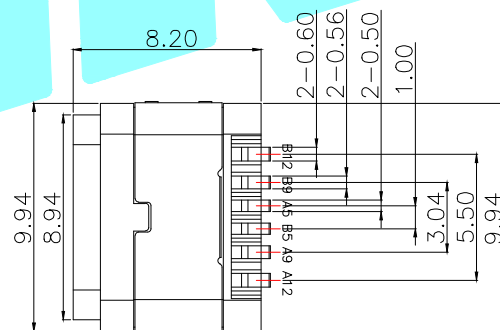
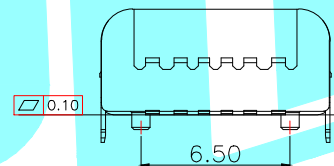
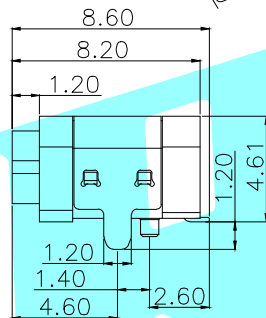
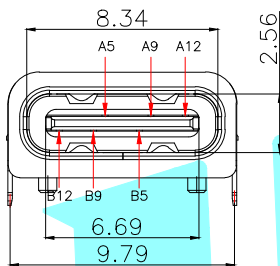
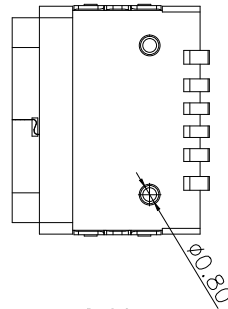
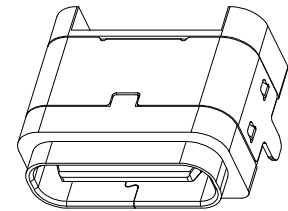

加防水圈示意图

⑥	防水圈	—	1	硅胶	Black
⑤	Shell	—	1	STAINLESS STEEL	Ni Plated
④	SHIELDING PLATE	—	1	STAINLESS STEEL	Ni Plated
③	Contact	—	1	COPPER ALLOY	TIN/Au/NI Plated
②	Shell Housing	—	1	HIGH TEMPERATURE PLASTIC	Black
①	Housing	—	1	HIGH TEMPERATURE PLASTIC	Black
ITEM	PART NAME	TER'NO.	QTY.	MATERIAL	FINISHING

APPROVALS		DATE		 ELECTRONICS CO.,LTD		
DRAWN	LIUCAN	2020.11.24				
CHECKED				PART NO.	TYPE-C-31-E-10	
APPROVALS				UNIT: mm	SCALE: 1:1	PROJ:
TOLERANCES ARE		30~以上	±0.30	ANGLE	DRAWING NO.	SHEET 1 OF 1
		10~30	±0.25			
		5~10	±0.20			
		~ 5	±0.15			

ECN NO.	REV.	DATE.	DESCRIPTION.	CHANGE.	CHECK.	APPRO.
—	A	—	NEW	—	—	—

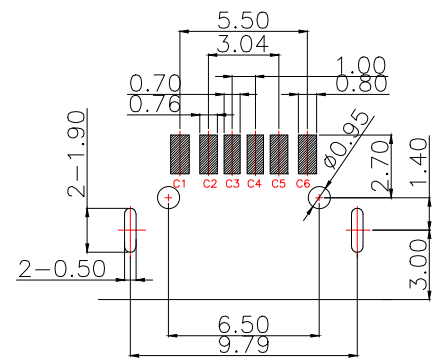
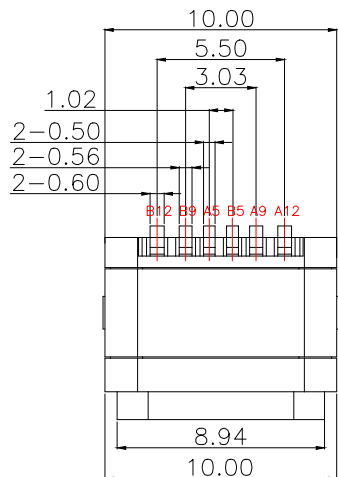

RECOMMENDED P.C.B. LAYOUT
TOLERANCE UNSPECIFIED ±0.05mm

- NOTES:
SPECIFICATION:
1. CURRENT RATING: 3.0A MAX
 2. VOLTAGE: 100 VAC
 3. TEMPERATURE RANGE: -30 °C ~ 85 °C
 4. CONTACT RESISTANCE: 40 MILLIONHM MAX
 5. INSULATION RESISTANCE: 100 MEGOHMS MIN.
 6. INSERTION FORCE: 5N~20N
 7. UNMATING FORCE: 8N~20N
 8. DURABILITY: 10,000 CYCLES
 9. WATER PROOFNESS: THIS PRODUCT IS BASED ON IPX7.

PIN NO	A1&B12	A4&B9	A5	A5	A9&B4	A12&B1
SIGNAL NAME	GND	VBUS	CC1	CC2	VBUS	GND
PCB PAD NO.	C1	C2	C3	C4	C5	C6

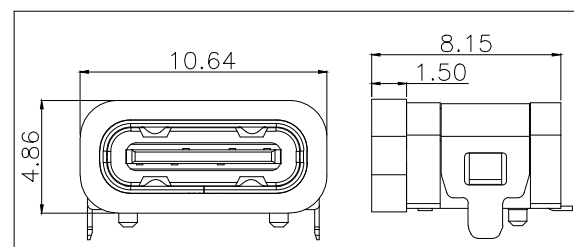
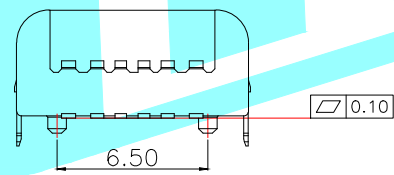
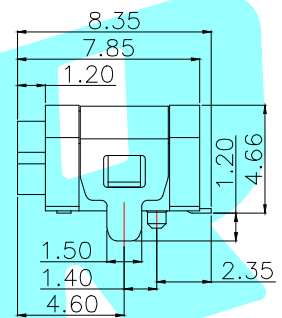
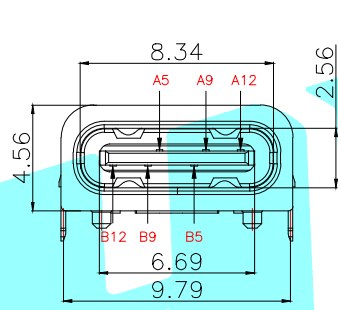

加防水圈示意图

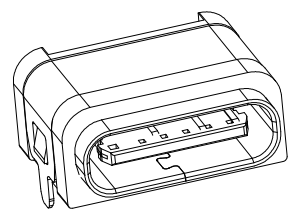
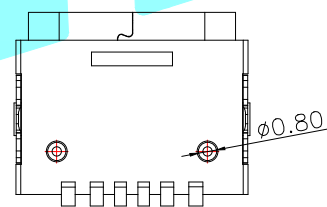

⑥	防水圈	—	1	硅胶	Black
⑤	Shell	—	1	STAINLESS STEEL	Ni Plated
④	SHIELDING PLATE	—	1	STAINLESS STEEL	Ni Plated
③	Contact	—	1	COPPER ALLOY	TIN/AU/NI Plated
②	Shell Housing	—	1	HIGH TEMPERATURE PLASTIC	Black
①	Housing	—	1	HIGH TEMPERATURE PLASTIC	Black
ITEM	PART NAME	TER'NO.	QTY.	MATERIAL	FINISHING

APPROVALS		DATE		 ELECTRONICS CO.,LTD		
DRAWN	LIUCAN	2021.6.10				
CHECKED				TITLE:	短款7.85MM长	
APPROVALS				PART NO.	TYPE-C-31-E-10X	
TOLERANCES ARE	30~以上	±0.30	ANGLE	UNIT: mm	SCALE: 1:1	PROJ:
	10~30	±0.25				
	5~10	±0.20	±2°	DRAWING NO.		SHEET 1 OF 1
	~ 5	±0.15				

ECN NO.	REV.	DATE.	DESCRIPTION.	CHANGE.	CHECK.	APPRO.
	A		NEW			